

L | XL

SPUL160LEDANXX



# u-light

Timo Ripatti



## u-light

Timo Ripatti

Collezione composta da lampade a parete, soffitto e sospensione in alluminio. Disponibile in due colori e diverse dimensioni. Sorgente luminosa a LED integrato dimmerabile. Disponibile con opzione fonoassorbente.

*Collection consisting of wall, ceiling and suspended lamps in aluminium. Available in two colours and few sizes. Built-in LED dimmable light source. Available with sound-absorbing panel option.*

**Prodotto fonoassorbente / Sound absorbing product**



### GENERAL INFORMATION



#### COLOURS



anthracite grey



rust brown

#### CANOPY



#### WALL AND CEILING LAMP VERSION



wall or ceiling details



wall, ceiling or pendant lamp canopy version



wall, ceiling or pendant lamp recessed version



acoustic performance



# u-light

Timo Ripatti

**SP ULI 090 LED**  
kg 7,2 m³ 0,19

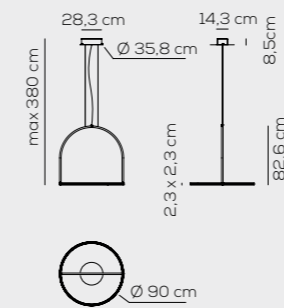

IP20 CRI90 **LED**

**U-LIGHT / downward lighting only / DRIVER INCLUDED**

3000K\*  
2700K upon request

**LED 63W** - diffused beam  
~5158 lm\* 82 lm/W\* source

100-240VAc

**Colours**  
AN anthracite / grey  
RU rust / brown

example composition code  
**SP ULI 090 LED AN XX**

other CCT options  
available upon request



**KITFASPULO90AAV, KITFASPUL120AAV**  
opzione fonoassorbente antracite /  
sound absorbing option anthracite

**KITFASPULO90RAV, KITFASPUL120RAV**  
opzione fonoassorbente ruggine /  
sound absorbing option rust brown

**SP ULI 120 LED**  
kg 8,2 m³ 0,33

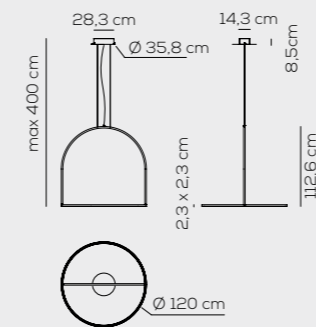

IP20 CRI90 **LED**

**U-LIGHT / downward lighting only / DRIVER INCLUDED**

3000K\*  
2700K upon request

**LED 86W** - diffused beam  
~7736 lm\* 90 lm/W\* source

100-240VAc

**Colours**  
AN anthracite / grey  
RU rust / brown

example composition code  
**SP ULI 120 LED AN XX**

**SP ULI 160**  
kg 18,8 m³ 0,6

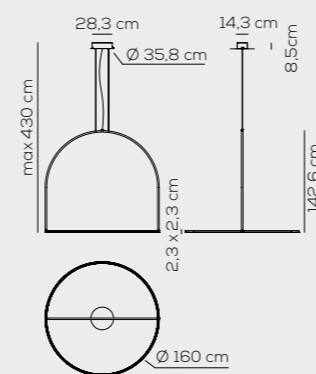

IP20 CRI90 **LED**

**U-LIGHT / downward lighting only / DRIVER INCLUDED**

3000K\*  
2700K upon request

**LED 125W** - diffused beam  
~9025 lm\* 72 lm/W\* source

100-240VAc

**Colours**  
AN anthracite / grey  
RU rust / brown

example composition code  
**SP ULI 160 LED AN XX**

pannello fonoassorbente non  
disponibile / sound absorbing  
panel not available

Project: Ekaterina Borisova-Shiyay Photo: Ivan Blagushin



SPULA160LEDRIUIN  
SPULA120LEDRIUIN

# u-light



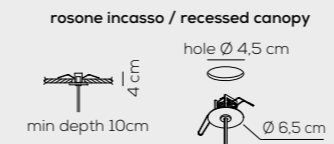
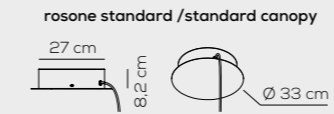
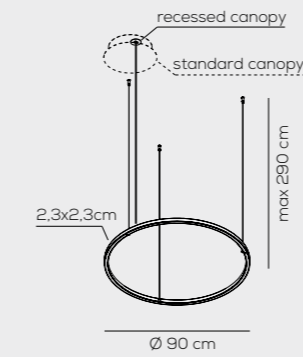

Timo Ripatti

**SP ULA 090 LED canopy**  
**SP ULA 090 LED recessed**  
canopy kg 5,8 m³ 0,128  
recessed kg 2,5 m³ 0,126

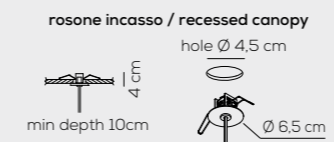
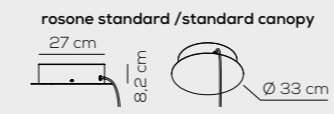
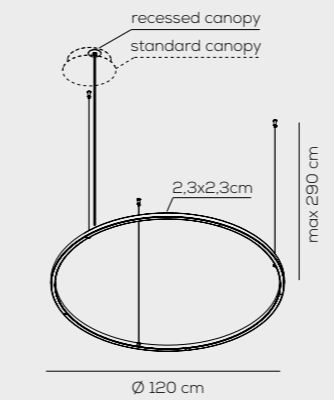

**SP ULA 120 LED canopy**  
**SP ULA 120 LED recessed**  
canopy kg 6,5 m³ 0,180  
recessed kg 3 m³ 0,150



 IP20  CRI90   LED

**U-LIGHT / suspension with canopy / DRIVER INCLUDED**





3000K\*  
2700K upon request

**LED 63W** - diffused beam  
~5158 lm\* 82 lm/W\* source

100-240VAc

**Colours**  
**AN** anthracite / grey  
**RU** rust / brown

example composition code  
**SP ULA 090 LED AN XX**

 IP20  CRI90   LED

**U-LIGHT / recessed suspension lamp / DRIVER NOT INCLUDED**

3000K\*  
2700K upon request



**LED 54W** - diffused beam  
~5158 lm\* 95 lm/W\* source





24Vdc

**Colours**  
**AN** anthracite / grey  
**RU** rust / brown

example composition code  
**SP ULA 090 LED AN IN**

foro - hole  $\varnothing$  4,5 cm / profondità min - min depth 10 cm

 **CEDMWC00202** dimmable 1-10V 24Vdc / driver max 80W  
 **CEDMWC00204** dimmable DALI 24Vdc / driver max 75W

 IP20  CRI90   LED

**U-LIGHT / suspension with canopy / DRIVER INCLUDED**





3000K\*  
2700K upon request

**LED 86W** - diffused beam  
~7736 lm\* 90 lm/W\* source

100-240VAc

**Colours**  
**AN** anthracite / grey  
**RU** rust / brown

example composition code  
**SP ULA 120 LED AN XX**

 IP20  CRI90   LED

**U-LIGHT / recessed suspension lamp / DRIVER NOT INCLUDED**

3000K\*  
2700K upon request



**LED 74W** - diffused beam  
~7736 lm\* 104 lm/W\* source

24Vdc

**Colours**  
**AN** anthracite / grey  
**RU** rust / brown

example composition code  
**SP ULA 120 LED AN IN**

foro - hole  $\varnothing$  4,5 cm / profondità min - min depth 10 cm

 **CEDMWC00203** dimmable 1-10V 24Vdc / driver max 100W  
 **CEDMWC00205** dimmable DALI 24Vdc / driver max 100W

Installazione downlight o uplight.  
Downlight or uplight mounting.

other CCT options  
available upon request



**KITFASPULA090AV**,  
**KITFASPULA000AV**  
opzione fonassorbente avorio /  
sound absorbing option ivory.

SPULA120LEDUIN  
KITFASPULA000AV



u-light 

Timo Ripatti

**SP ULA 160 LED canopy**  
**SP ULA 160 LED recessed**  
canopy kg 9,1 m³ 0,310  
recessed kg 4,8 m³ 0,280

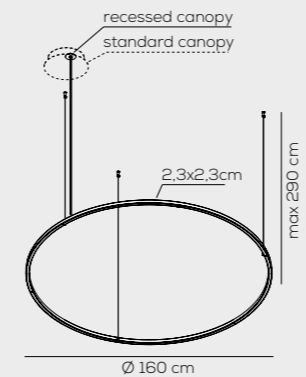





rosone standard / standard canopy



rosone incasso / recessed canopy



 IP20  CRI90   LED

U-LIGHT / suspension with canopy / DRIVER INCLUDED





3000K\*  
2700K upon request

LED 125W - diffused beam  
~9025 lm\* 72 lm/W\* source

100-240V<sub>AC</sub>

Colours  
AN anthracite / grey  
RU rust / brown

example composition code  
SP ULA 160 LED AN XX

 IP20  CRI90   LED

U-LIGHT / recessed suspension lamp / DRIVER NOT INCLUDED

3000K\*  
2700K upon request



LED 102W - diffused beam  
~9025 lm\* 88 lm/W\* source

24V<sub>DC</sub>

Colours  
AN anthracite / grey  
RU rust / brown

example composition code  
SP ULA 160 LED AN IN

foro - hole Ø 4,5 cm / profondità min - min depth 10 cm

 CEDMWC00202 dimmable 1-10V 24V<sub>DC</sub>  
driver max 80W x 2 pcs  
 CEDMWC00204 dimmable DALI 24V<sub>DC</sub>  
driver max 75W x 2 pcs

**SP ULA 180 LED canopy**  
**SP ULA 180 LED recessed**  
canopy kg 10,5 m³ 0,330  
recessed kg 5,4 m³ 0,310

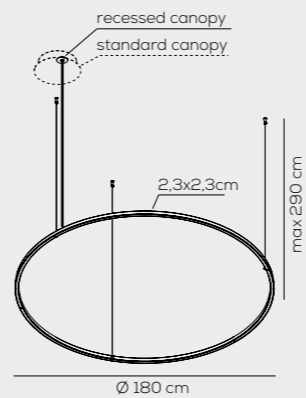





rosone standard / standard canopy

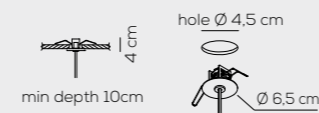

rosone incasso / recessed canopy



 IP20  CRI90   LED

U-LIGHT / suspension with canopy / DRIVER INCLUDED





3000K\*  
2700K upon request

LED 153W - diffused beam  
~10315 lm\* 67 lm/W\* source

100-240V<sub>AC</sub>

Colours  
AN anthracite / grey  
RU rust / brown

example composition code  
SP ULA 180 LED AN XX

 IP20  CRI90   LED

U-LIGHT / recessed suspension lamp / DRIVER NOT INCLUDED

3000K\*  
2700K upon request



LED 123W - diffused beam  
~10315 lm\* 84 lm/W\* source

24V<sub>DC</sub>

Colours  
AN anthracite / grey  
RU rust / brown

example composition code  
SP ULA 180 LED AN IN

foro - hole Ø 4,5 cm / profondità min - min depth 10 cm

 CEDMWC00203 dimmable 1-10V 24V<sub>DC</sub>  
driver max 100W x 2 pcs  
 CEDMWC00205 dimmable DALI 24V<sub>DC</sub>  
driver max 100W x 2 pcs

Installazione downlight o uplight.  
Downlight or uplight mounting.





other CCT options  
available upon request



KITFASPULA000AV  
opzione fonoassorbente avorio /  
sound absorbing option ivory.



PL UL 1 090 LED h10 cm canopy  
PL UL 2 090 LED h25 cm canopy  
PL UL 1: kg 5,8 m³ 0,128  
PL UL 2: kg 6,3 m³ 0,128

 IP20  CRI90  dimmable  LED

U-LIGHT / h10 cm or h25 cm ceiling lamp with canopy / DRIVER INCLUDED

3000K\*  
2700K upon request

LED 63W - diffused beam  
~5158 lm\* 82 lm/W\* source

100-240VAc

Colours  
AN anthracite / grey  
RU rust / brown

example composition code  
PL UL1 090 LED AN XX

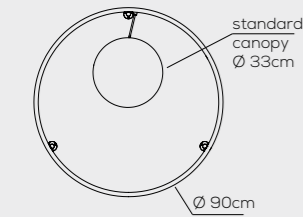



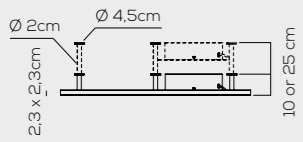

rosone standard / standard canopy

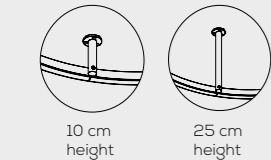

altezze disponibili  
available heights



PL UL 1 090 LED h10 cm recessed  
PL UL 2 090 LED h25 cm recessed  
PL UL 1: kg 2,7 m³ 0,126  
PL UL 2: kg 3,1 m³ 0,126

 IP20  CRI90  dimmable with dedicated PSU  LED

U-LIGHT / h10 cm or h25 cm recessed ceiling lamp / DRIVER NOT INCLUDED

3000K\*  
2700K upon request

LED 54W - diffused beam  
~5158 lm\* 95 lm/W\* source

24Vdc

Colours  
AN anthracite / grey  
RU rust / brown

example composition code  
PL UL1 090 LED AN IN

foro - hole Ø 4,5 cm / profondità min - min depth 10 cm

 CEDMWC00202 dimmable 1-10V 24Vdc / driver max 80W

 CEDMWC00204 dimmable DALI 24Vdc / driver max 75W

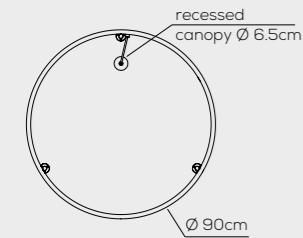



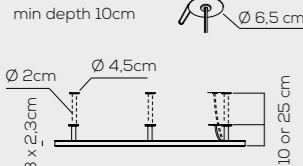

rosone incasso / recessed canopy

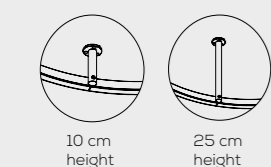

altezze disponibili  
available heights



PL UL 1 120 LED h10 cm canopy  
PL UL 2 120 LED h25 cm canopy  
PL UL 1: kg 6,6 m³ 0,180  
PL UL 2: kg 7 m³ 0,180

 IP20  CRI90  dimmable  LED

U-LIGHT / h10 cm or h25 cm ceiling lamp with canopy / DRIVER INCLUDED

3000K\*  
2700K upon request

LED 86W - diffused beam  
~7736 lm\* 90 lm/W\* source

100-240VAc

Colours  
AN anthracite / grey  
RU rust / brown

example composition code  
PL UL1 120 LED AN XX

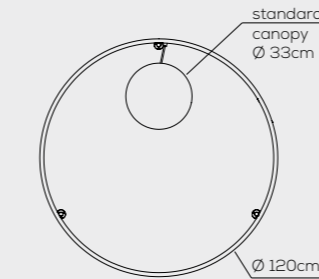

rosone standard / standard canopy

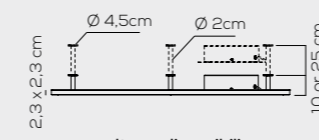

altezze disponibili  
available heights

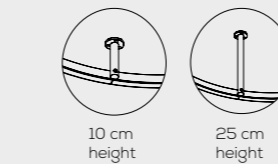





Installazione come plafoniera  
(downlight o uplight) oppure  
applique (con illuminazione verso  
la superficie di installazione).  
Application: both as ceiling  
(downlight or uplight mounting)  
or wall lamp (only wallward light).

other CCT options  
available upon request



KITFAPLULA090AV (canopy),  
KITFAPLUL090IAV (recessed)  
opzione fonoassorbente avorio /  
sound absorbing option ivory.

PL UL 1 120 LED h10 cm recessed  
PL UL 2 120 LED h25 cm recessed  
PL UL 1: kg 3,2 m³ 0,150  
PL UL 2: kg 3,6 m³ 0,150

 IP20  CRI90  dimmable with dedicated PSU  LED

U-LIGHT / h10 cm or h25 cm recessed ceiling lamp / DRIVER NOT INCLUDED

3000K\*  
2700K upon request

LED 74W - diffused beam  
~7736 lm\* 104 lm/W\* source

24Vdc

Colours  
AN anthracite / grey  
RU rust / brown

example composition code  
PL UL1 120 LED AN IN

foro - hole Ø 4,5 cm / profondità min - min depth 10 cm

 CEDMWC00203 dimmable 1-10V 24Vdc / driver max 100W

 CEDMWC00205 dimmable DALI 24Vdc / driver max 100W

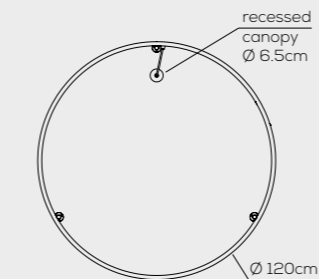

rosone incasso / recessed canopy

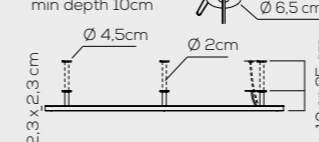
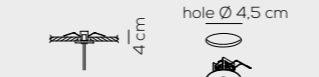

altezze disponibili  
available heights

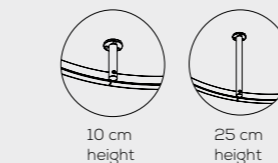

Installazione come plafoniera  
(downlight o uplight) oppure  
applique (con illuminazione verso  
la superficie di installazione).  
Application: both as ceiling  
(downlight or uplight mounting)  
or wall lamp (only wallward light).

other CCT options  
available upon request



KITFAPLULA120AV (canopy),  
KITFAPLUL120IAV (recessed)  
opzione fonoassorbente avorio /  
sound absorbing option ivory.

PLUL1160LEDANXX  
KITFAPLULA000AV

# u-light

Timo Ripatti

PL UL 1 160 LED h10 cm canopy  
PL UL 2 160 LED h25 cm canopy  
PL UL 1: kg 9,2 m³ 0,310  
PL UL 2: kg 9,6 m³ 0,310

IP20 CRI90  LED

U-LIGHT / h10 cm or h25 cm ceiling lamp with canopy / DRIVER INCLUDED

3000K\*  
2700K upon request

LED 125W - diffused beam  
~9025 lm\* 72 lm/W\* source

100-240VAc

Colours  
AN anthracite / grey  
RU rust / brown

example composition code  
PL UL1 160 LED AN XX

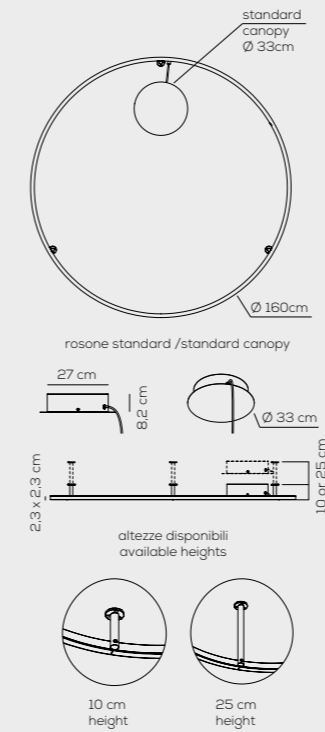

PL UL 1 160 LED h10 cm recessed  
PL UL 2 160 LED h25 cm recessed  
PL UL 1: kg 5 m³ 0,280  
PL UL 2: kg 5,4 m³ 0,280

IP20 CRI90  LED

U-LIGHT / h10 cm or h25 cm recessed ceiling lamp / DRIVER NOT INCLUDED

3000K\*  
2700K upon request

LED 102W - diffused beam  
~9025 lm\* 88 lm/W\* source

24Vdc

Colours  
AN anthracite / grey  
RU rust / brown

example composition code  
PL UL1 160 LED AN IN

foro - hole Ø 4,5 cm / profondità min - min depth 10 cm

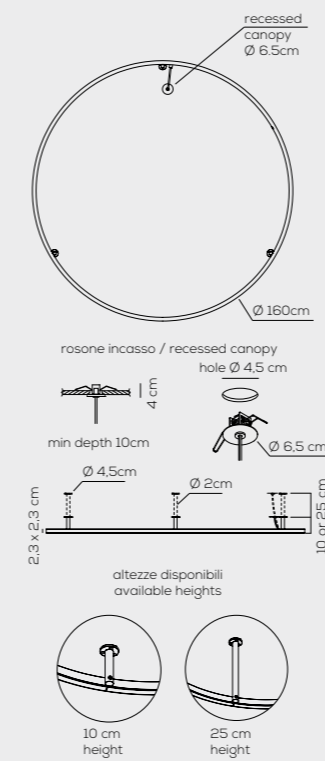

Installazione come plafoniera  
(downlight o uplight) oppure  
applique (con illuminazione verso  
la superficie di installazione).  
Application: both as ceiling  
(downlight or uplight mounting)  
or wall lamp (only wallward light).

other CCT options  
available upon request



KITFAPLULA000AV (canopy),  
KITFAPLUL000IAV (recessed)  
opzione fonoassorbente avorio /  
sound absorbing option ivory.

 CEDMWC00202 dimmable 1-10V 24Vdc  
driver max 80W x 2 pcs  
CEDMWC00204 dimmable DALI 24Vdc  
driver max 75W x 2 pcs

# u-light

Timo Ripatti

PL UL 1 180 LED h10 cm canopy  
 PL UL 2 180 LED h25 cm canopy  
 PL UL 1: kg 6,6 m³ 0,180  
 PL UL 2: kg 7 m³ 0,180

IP20 CRI90 **LED**

U-LIGHT / h10 cm or h25 cm ceiling lamp with canopy / DRIVER INCLUDED

3000K\*  
 2700K upon request

LED 153W - diffused beam  
 ~10315 lm\* 67 lm/W\* source

100-240VAc

Colours  
**AN** anthracite / grey  
**RU** rust / brown

example composition code  
**PL UL1 180 LED AN XX**

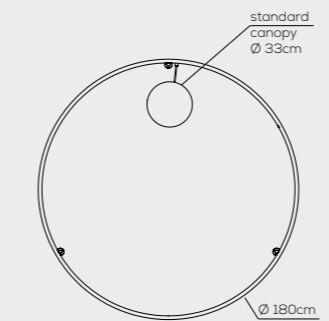

rosone standard / standard canopy

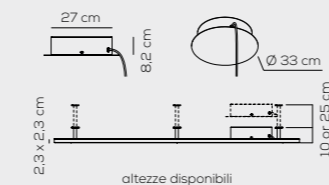

altezze disponibili  
 available heights

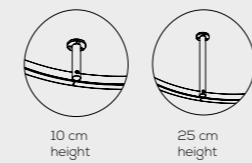

PLUL1090LEDRUXX  
 PLUL1160LEDRUXX  
 PLUL2120LEDRUXX



PL UL 1 180 LED h10 cm recessed  
 PL UL 2 180 LED h25 cm recessed  
 PL UL 1: kg 3,2 m³ 0,150  
 PL UL 2: kg 3,6 m³ 0,150

IP20 CRI90 **LED**

U-LIGHT / h10 cm or h25 cm recessed ceiling lamp / DRIVER NOT INCLUDED

3000K\*  
 2700K upon request

LED 123W - diffused beam  
 ~10315 lm\* 84 lm/W\* source

24Vdc

Colours  
**AN** anthracite / grey  
**RU** rust / brown

example composition code  
**PL UL1 180 LED AN IN**

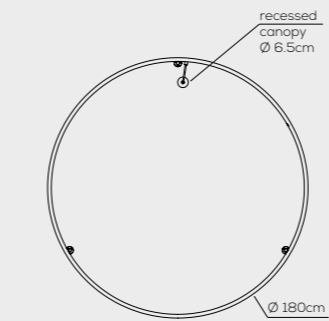

rosone incasso / recessed canopy  
 hole Ø 4,5 cm

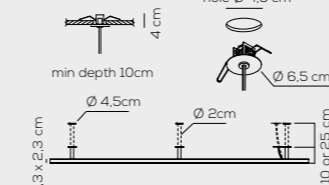

altezze disponibili  
 available heights

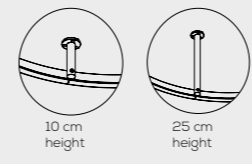

foro - hole Ø 4,5 cm / profondità min - min depth 10 cm

**CEDMWC00203** dimmable 1-10V 24Vdc driver max 100W x 2 pcs  
**CEDMWC00205** dimmable DALI 24Vdc driver max 100W x 2 pcs

Installazione come plafoniera (downlight o uplight) oppure applique (con illuminazione verso la superficie di installazione).  
 Application: both as ceiling (downlight or uplight mounting) or wall lamp (only wallward light).

other CCT options available upon request



KITFAPLULA000AV (canopy),  
 KITFAPLUL000IAV (recessed)  
 opzione fonoassorbente avorio /  
 sound absorbing option ivory.